

BADEWANNE • BATHTUBES • ВАННЫ • BAIGNOIRE

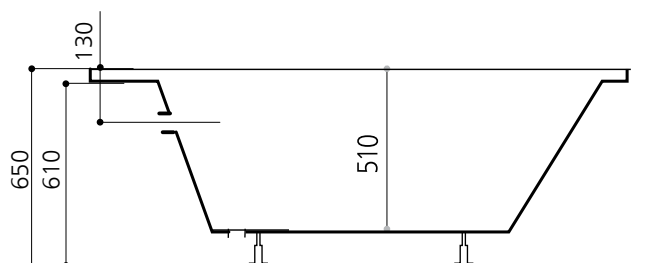

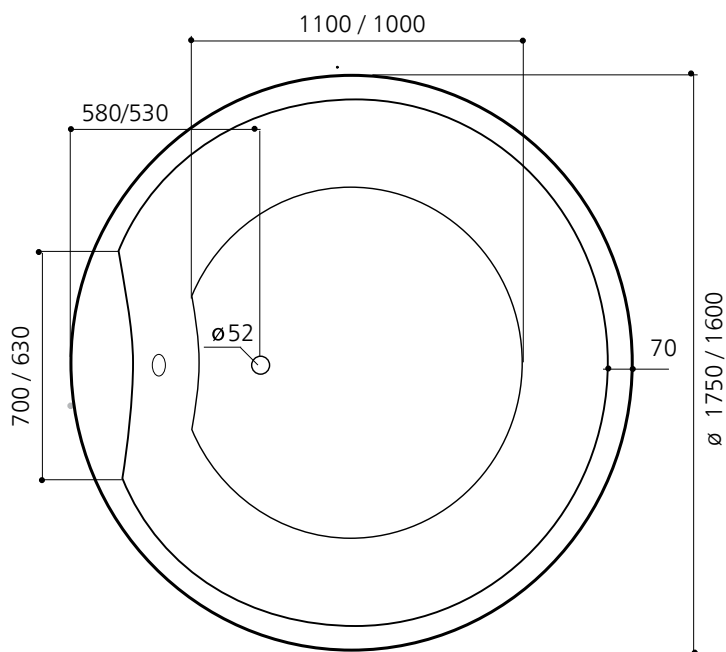

MASSE • MEASUREMENTS • ИЗМЕРЕНИЕ • MESURES

SpaVida

**SOLAR** Ø175/51, Ø160/51

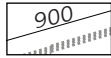

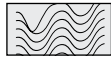
**SOLAR** Ø175/51 - 560L, Ø160/51 - 460L

-  • ANSCHLUSSBEREICH/ABLAUF - OUTFLOW
-  • ANSCHLUSSBEREICH / WANDARMATUR - CONNECTION AREA FOR WALL FAUCET
-  • WASSERANSCHLUSS BEREICH FÜR ARMATUR U. DESINFEKTION - WATER CONNECTION AREA FOR THE BATH-FAUCET AND DISINFECTION
-  • BADEWANNE ARMATUR - BATHTUB FAUCET
-  • ELEKTRIZITÄT; STROM 230V, 50HZ, 16A, 3x2,5mm<sup>2</sup>, Lg. 150cm, POTENTIALAUSGLEICHLEITUNG 1x4mm<sup>2</sup>, Lg. 150cm

